

Quality made in Germany

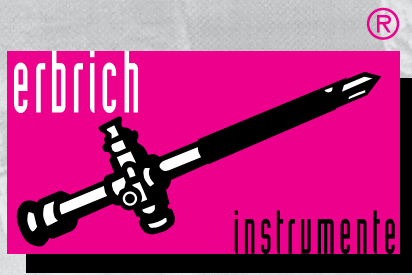

Instrumente für Linkshänder  
Instruments for Lefthänder







WEBSTER



HALSEY



HEGAR-BAUMGARTNER



CRILE-WOOD

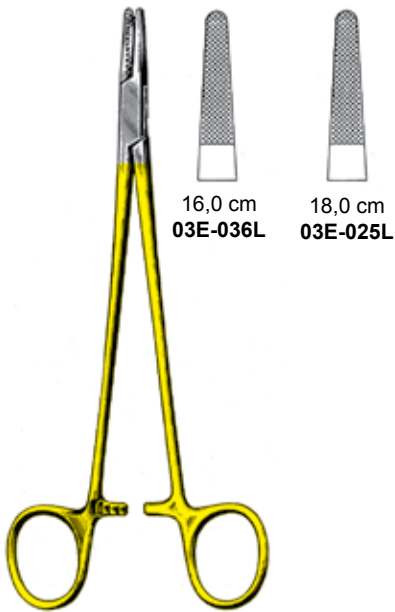

MAYO-HEGAR



RYDER

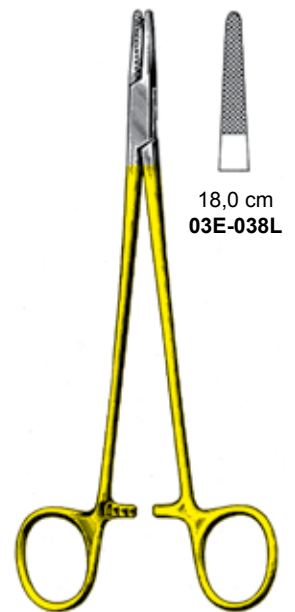

DE BAKAY

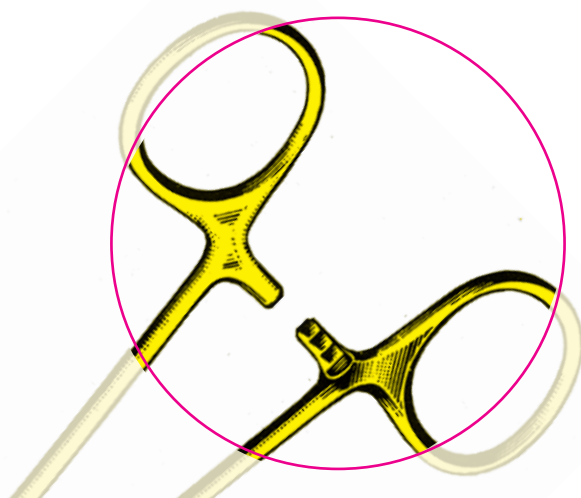

Chirurgische Scheren  
Surgical Scissors

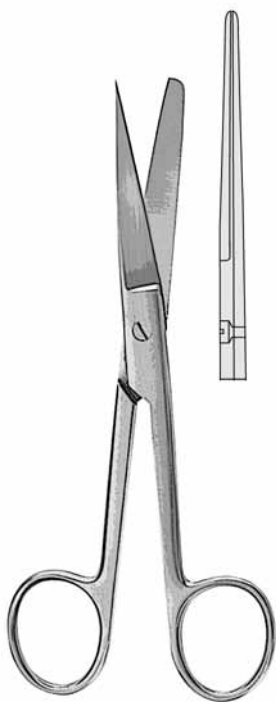

14,5 cm  
21E-017L

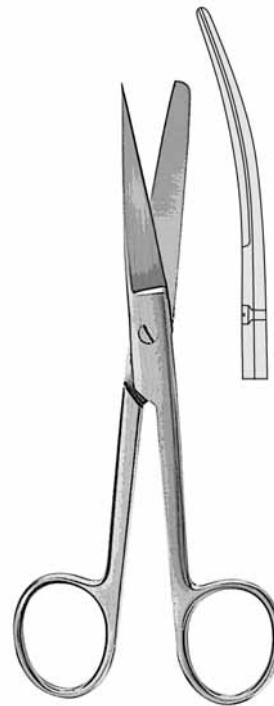

14,5 cm  
21E-038L

gebogen  
curved

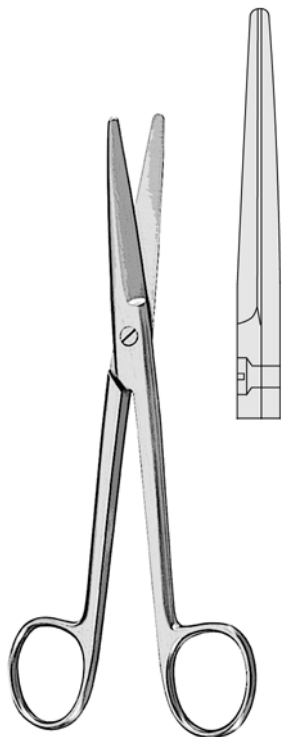

MAYO  
14,5 cm 21E-043L  
17,0 cm 21E-044L

gerade  
straight

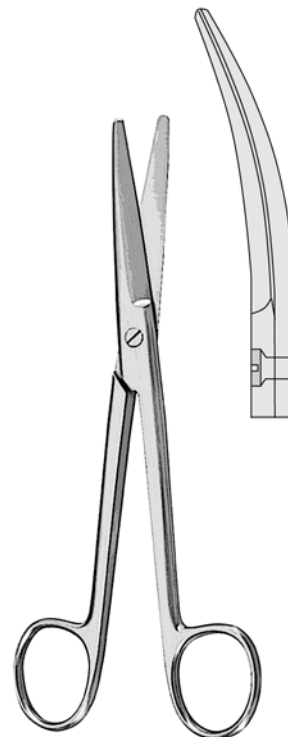

MAYO  
14,5 cm 21E-045L  
17,0 cm 21E-046L

gebogen  
curved

Scheren - Linkshänder  
Scissors - Left hander

Präparierscheren  
Dissecting Scissors

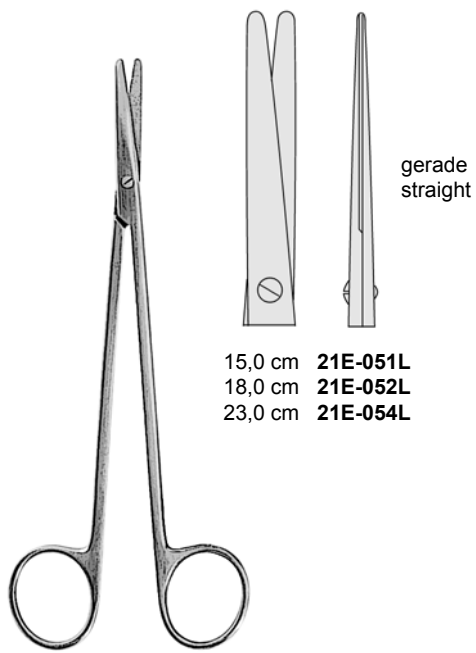

gerade  
straight

- 15,0 cm **21E-051L**
- 18,0 cm **21E-052L**
- 23,0 cm **21E-054L**

METZENBAUM-NELSON

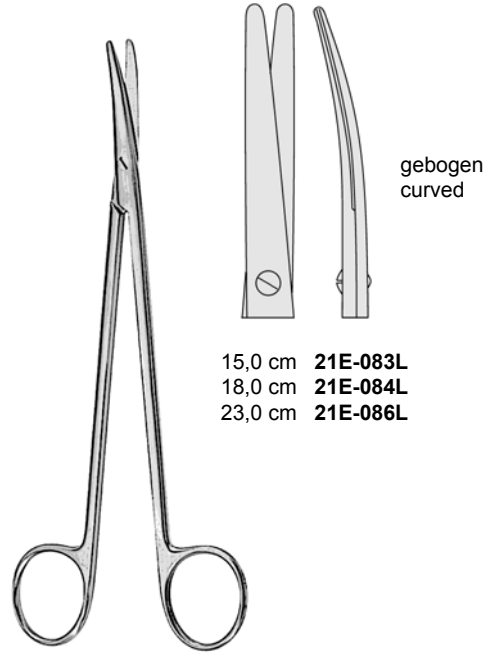

gebogen  
curved

- 15,0 cm **21E-083L**
- 18,0 cm **21E-084L**
- 23,0 cm **21E-086L**

METZENBAUM-NELSON

Verbandsscheren  
Bandage Scissors

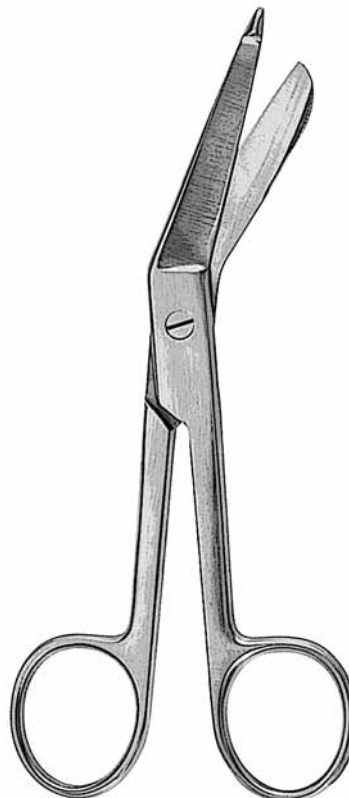

LISTER  
14,5 cm  
**21E-076L**

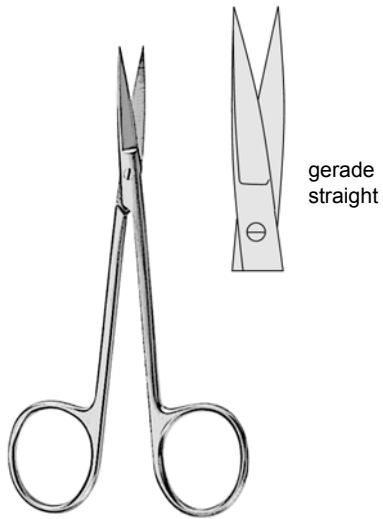
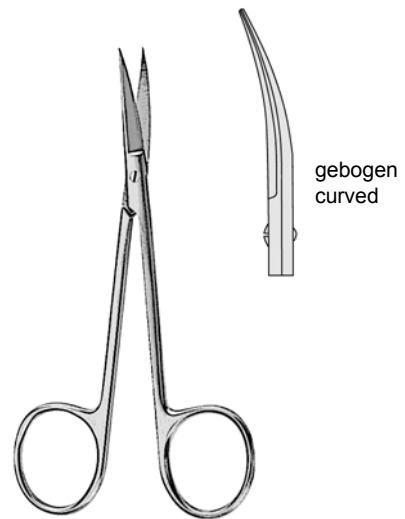
Augenscheren  
Eye ScissorsIRIS  
10,5 cm  
**22E-048L**IRIS  
10,5 cm  
**22E-049L**



Technische Änderungen vorbehalten  
Technical features are subject to change  
Cambios técnicos reservados  
Ci riserviamo il diritto di modifiche tecniche

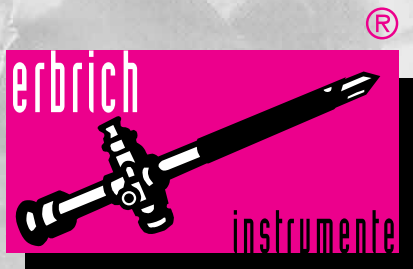

erbrich - instrumente GmbH  
Eugenstr. 33 · D-78532 Tuttlingen  
Tel.: +49 74 61 / 96 57 30  
Fax: +49 74 61 / 9657 320  
E-mail: [info@erbrich-instrumente.de](mailto:info@erbrich-instrumente.de)  
Website: [www.erbrich-instruments.com](http://www.erbrich-instruments.com)